



the System





There is a reason why LEE Filters has established a worldwide reputation for quality that is second to none. It is because every filter that leaves the factory has been handmade and inspected by one of our highly skilled staff, who ensure it meets our exacting standards. This rigorous process and attention to detail at every level means that LEE Filters has, since its inception in 1978, been assured of its position as the benchmark in camera filters – its status backed up by the many photographers worldwide who continue to recommend its products for both film and digital photography.

Despite the wide availability of image manipulation programmes, digital photographers are increasingly recognising the benefits of refining the image and ensuring it is correct in-camera. The less work required at the computer, the more time can be spent in the field.

Any system has to start with the fundamentals, and with LEE Filters it is no different. At the core of any photographer's kit – whether amateur or professional, and whether shooting film or digital – is the filter holder. Deceptively simple and highly versatile, it is all any photographer needs to ensure accurate and creative results.

A long-established history of supplying filters to the film, television and theatre lighting markets, where the demands are stringent and exacting, gives LEE Filters the freedom to apply the same principles to its photographic products. It's quite simple. Inferior filters result in a loss of picture quality. LEE Filters, however, offers the assurance that its products complement the standards set by camera and lens manufacturers. Compromising picture quality is not an option.

Front cover photography by David Noton. ([www.davidnoton.com](http://www.davidnoton.com))

4 Getting started	9 The system	10 The filter holder	14 Adaptor rings
16 Lens hoods	19 Filters	22 Neutral density filters	24 Polarising filter
26 Resin sets	34 Soft focus filters	36 The glass enhancer	37 Single effect filters
41 Technical filters	42 Polyester technical sets	48 Filters for black & white photography	50 Accessories
52 Pouches	53 The RF75 filter system	60 Lighting Filters	61 Index

# Getting started

Getting started

## Starter kit

If you're new to the LEE Filters system, this is what you'll need to set you on your way. Crucially, the Starter Kit comes with the filter holder already assembled, so all you need is to slot in either the 0.6 neutral density (ND) grad, or the Coral 3 grad (which has enough tone to be used both as a grad or an all-over filter) clip it to your adaptor ring\*, and start shooting. The cleaning cloth ensures the filters remain free of dust, and it's all packed in a neat triple pouch.

Your Starter Kit includes:

- Filter holder
- 0.6 ND hard grad (100x150mm)
- Coral 3 hard grad (100x150mm)
- Cleaning cloth
- Pouch



## Digital SLR Starter Kit

Like the standard Starter Kit, a ready-assembled filter holder comes as standard with this kit. However, the main difference lies in the inclusion of a ProGlass 0.6 standard ND filter. ProGlass filters are designed to cut out more infrared and UV light than the standard versions. The result? A cleaner, crisper result, with fewer colour aberrations when shooting in challenging light. Also included in the kit is a 0.6 ND hard grad, cleaning cloth and triple pouch.

Your Digital SLR Starter Kit includes:

- Filter holder
- ProGlass 0.6 ND standard (100x100mm)
- 0.6 ND hard grad (100x150mm)
- Cleaning cloth
- Triple pouch



\*not included

## Foundation kit

The Foundation Kit – the basic filter holder – attaches to the camera's lens via an adaptor ring. The holder is suitable for between one and four filters and is compatible with any camera format, whether film or digital.

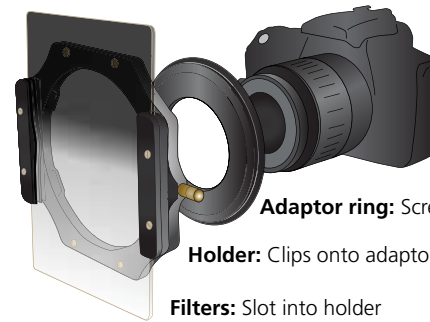

**Adaptor ring:** Screws onto lens

**Holder:** Clips onto adaptor ring

**Filters:** Slot into holder



## Universal hood

A versatile accessory, the Universal Hood shades lenses on any camera from DSLR or film SLR to medium format. It comes assembled with two filter slots, but can also be configured to take different filter combinations. It allows the effects of flare to be controlled, leaving the photographer to concentrate on creative composition.



Getting started

# Getting started

Getting started

## Neutral density filters

There are two types of neutral density filter: graduated and standard. Both are typically available in strengths of 0.3, 0.6 and 0.9 – equating to one, two and three stops respectively.

**Neutral density filters have no impact on colour balance, and should not be confused with grey filters.** They can be used alone or in combination with other types of filter – a warm-up, for example.

## Neutral density graduated filters

The neutral density graduated filter (also known as an ND grad) is used to balance the exposure within a scene – typically when the sky is brighter than the foreground.

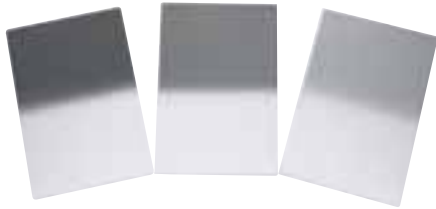

### Professional hint

ND grads can be used both horizontally and at an angle, and more than one can be stacked on top of the other for extreme variations in exposure across the composition.

## Neutral density standard filters

**The only difference between ND grads and ND standards is that the standard is coated evenly across the entire filter, rather than partially.**

The ND standard is used in two main ways: to reduce the quantity of light hitting the camera's sensor, or film, permitting longer shutter speeds; and to reduce the sensitivity of a sensor in a DSLR that has a high minimum ISO setting (ISO 200 or above).

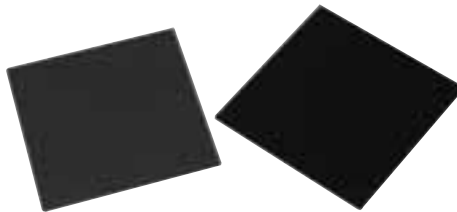

### Professional hint

When first using ND standards, experiment with slow shutter speeds in order to learn exactly their impact on moving subjects, such as clouds, water or windblown leaves.

6 | the System

## RF75 filter system

(filter size 75x90mm)

Who better to help design a new photographic product than photographers themselves? The pioneering RF75 filter system is unique, and ingenious. And it isn't just the people at LEE Filters who think so. 'Voigtländer, Zeiss Ikon, Mamiya 7, Leica, Xpan and Bronica 645 owners should... be excited about it.' Those are the words of renowned landscape photographer Joe Cornish.

The principle behind the RF75 is to offer a solution to rangefinder photographers who are sometimes impeded by the size of standard filters, which can block part of the viewfinder or even cause difficulties with taking light readings.

**The RF75 is compact, lightweight, designed to fit lenses with diameters of 67mm or less – and won't completely obstruct the viewfinder.**



Fundamental to its design is the laser-etched front element, which allows graduated filters to be positioned accurately, even when their effect cannot be assessed through the viewfinder. The holder has been designed to work on some of the widest-angle lenses with at least one filter and a polariser. And it's not just for rangefinder photographers. The RF75 is equally at home on the front of many higher end digital compact cameras.



See page 53 for an in-depth introduction to the RF75 kit.

Getting started

7 | the System

## Getting started

### ■ Polariser

When light bounces off a flat, non-metallic surface – such as glass or water – it becomes polarised. This means that all the reflected lightwaves vibrate in the same plane. The result is glare, which creates extremes of contrast, is difficult to control, and generally confuses the scene. **A polarising filter cuts out this glare, removes reflections and results in more saturated colours.** The strength of the polarised effect depends on the rotation of the polarising filter.

Polarising filters are available in two types: linear and circular. See page 24 for a full explanation of these terms.



### ■ Professional hint

One of the main functions of the polariser is to cut polarised light from blue skies. This results in an increase in contrast between the sky and any white clouds in the scene. The effect is at its strongest when the filter is used at a 90-degree angle to the sun.

### ■ Learn the best way to use your filters



Whether you shoot film or digital, *Inspiring Professionals* is the only guide to using filters you'll ever need. Produced by LEE Filters, with contributions from professionals at the top of their field, the 132-page hardback book features not only some of the finest landscape and architectural photography, but also numerous hints and tips from the likes of **Joe Cornish, Charlie Waite, David Ward, Mark Denton, John Gravett, David Noton, Jeremy Walker and Tom Mackie.**

### ■ Inspiration and education

David Noton has received worldwide acclaim for his landscape and travel photography, and his DVD, *Chasing the Light*, brings together his knowledge and expertise on the subject. **Covering topics such as location, light, composition and postproduction, not to mention numerous hands-on tutorials at inspiring locations,** *Chasing the Light* demonstrates how a photographer's development evolves when both artistry and technique are balanced.



## The System



At the core of the LEE Filters system is the holder, which can be constructed with up to four slots, and is intended to be versatile and straightforward to use, freeing up the photographer to concentrate on taking the picture. **The holder is designed to be compatible with 100mm filters – LEE Filters' standard width.**

To fit the holder to the lens, an adaptor ring is required. There are two types of LEE Filter adaptor ring: one for general use, and one for wideangle lenses.

### ■ Contents

- 10 Holder versatility
- 12 The foundation kit
- 14 Adaptor rings
- 16 Lens hoods

# Holder versatility

The LEE Filters holder has been designed with almost every photographic eventuality and combination in mind. **Up to four filters can be used in one holder**, permitting the combination of different types of filter, such as neutral density and warm-up if shooting colour, whether film or digital, or red and neutral density standard (to darken blue skies and slow down the exposure) if shooting with black & white film, for example.

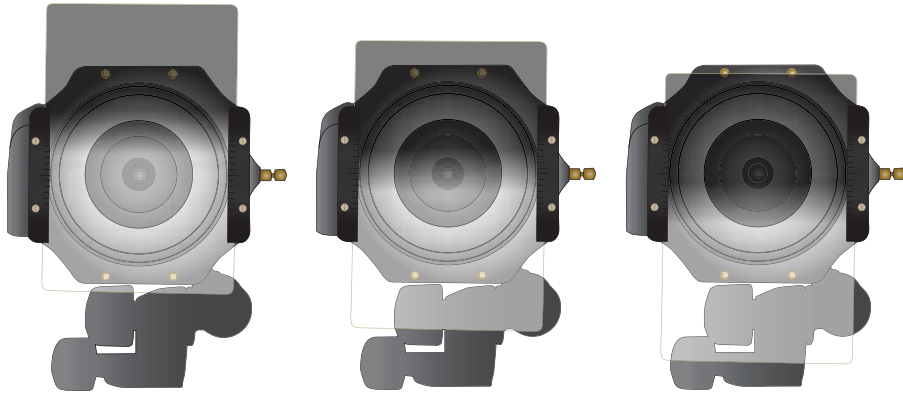

To position the graduation line slide the filter up and down in the holder.

Crucially, once fitted to the adaptor ring, **the holder can be rotated to any angle**. This permits the photographer to balance the exposure even when the brightest areas fall, say, within the top left hand 'triangle' of the scene.

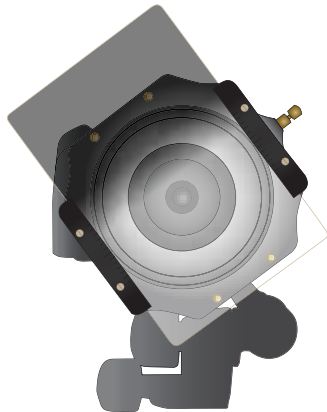

### Professional hint

Don't forget that ND grads can also be used 'upside down' – with the filtered section at the bottom and the unfiltered section at the top – on occasions when the lower part of the frame is brighter than the top part.

An ND grad should be positioned at the point where the brightest area of the frame meets the darker area. This is achieved simply by sliding the filter up and down in its holder, assessing the effect through the viewfinder, until the correct point is reached.



When using multiple filters in one holder, it is crucial to take into account the possibility of vignetting. **The higher the number of filter guides, the narrower the angle of view becomes** and, therefore, the higher the likelihood of vignetting. The approximate limitations are as follows:

Number of filter guides	Minimum focal length
One	16mm
Two	17mm
Three	21-24mm

\* All focal lengths are full-frame digital or 35mm SLR equivalents

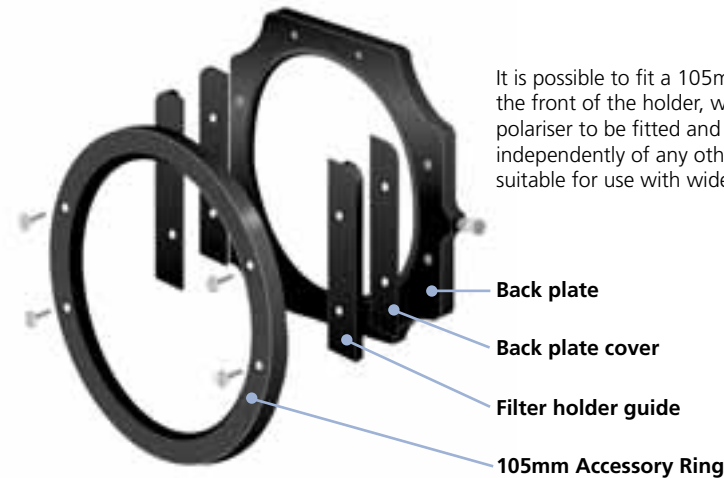

It is possible to fit a 105mm accessory ring to the front of the holder, which allows a polariser to be fitted and rotated independently of any other filters. It is also suitable for use with wideangle lenses.

# □ Holders

## □ The foundation kit

The Foundation Kit is fundamental to the LEE Filters system. It takes standard 100mm filters, and can be constructed to take up to three filters at any one time (remember, though, the more filter guides added, the higher the likelihood of vignetting with wideangle lenses). The Foundation Kit, like all others, clips onto the adaptor ring which, in turn, screws onto your camera's lens.



## □ How the holder is constructed

- Fit the back cover plates to the back plate (see diagram below)
- Fit the filter holder guides (up to four guides, or slots, can be used with one holder) to the back cover plates
- Fit the front cover plates to the filter holder guides

### Single filter configuration

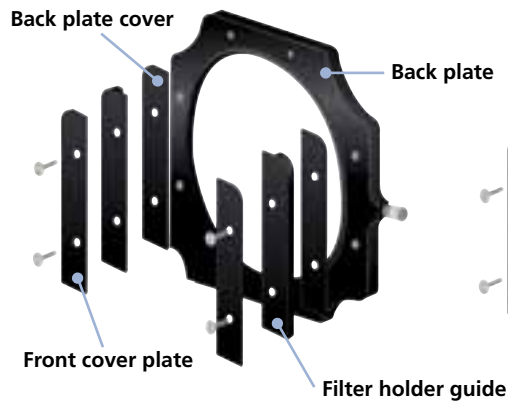

### Three filter configuration

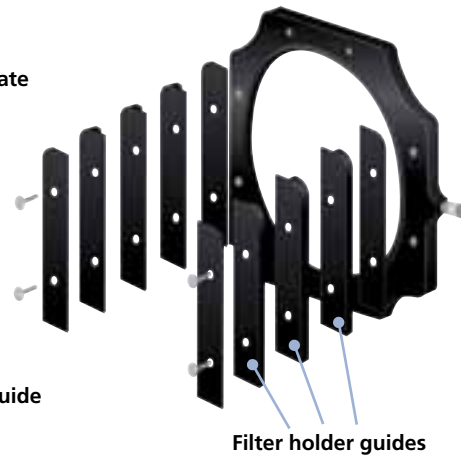

## □ Professional kit

The Professional Kit features two filter holders and a tandem adaptor to join them together. This allows independent rotation of grads, as well as the option to use more than four filters if desired.



## □ Upgrade kit

The Upgrade Kit contains a filter holder and a tandem adaptor and converts your foundation holder into a professional kit.

## □ Push-on filter holder

The push-on filter holder has been specifically designed to fit straight to certain large format wideangle lenses which otherwise will not take a filter system. It takes the standard 100mm filters and fits directly to lenses with an outside diameter of 100mm (filter thread often 95mm). It can be custom adapted to fit lenses or centre filters of smaller diameter, but is not generally the best option for sizes less than 86mm.



## □ Specialist filter holders

LEE Filters also offers a custom-made filter holder service. This opens up the possibility of using filters with lenses which would otherwise be incompatible. Such holders are customised to the photographer's needs.

# Adaptor rings



The adaptor ring is crucial to the LEE Filters system. It screws onto the camera's lens and, in turn, the filter holder clips onto the adaptor ring.

The adaptor ring screws onto the lens with a fluid action, thanks to the sturdy construction and aluminium screw thread.

## Standard adaptor rings are available in the following thread sizes:

49, 52, 55, 58, 62, 67, 72, 77, 82, 86, 93 and 105mm, as well as Rollei IV, and 50, 60 and 70mm bayonet fitting for Hasselblad lenses.

*Special sizes can be made to order*

## Wideangle adaptor rings are available in the following thread sizes:

49, 52, 55, 58, 62, 67, 72, 77, 82mm.

*Special sizes can be made to order*

## Standard adaptor ring

The standard adaptor ring is suitable for use with lenses up to a moderate wideangle. It sits in front of the lens's front thread.

The standard adaptor ring is compatible with lens focal lengths of approximately 24-28mm (35mm SLR equivalent) and upwards.

Standard adaptor

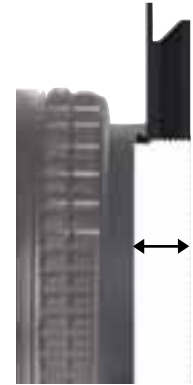

## Wideangle adaptor ring

The wideangle adaptor ring is suitable for use with wideangle lenses. It differs from the standard adaptor ring by sitting closer to the front element of the camera's lens. As a result, the likelihood of vignetting is dramatically reduced.

## Professional hint

The wideangle adaptor ring is compatible with all lens focal lengths.

Wide-angle adaptor



# ■ Lens hoods



All LEE Filters lens hoods are self-supporting – a feature unique to the manufacturer. This means, quite simply, they have no need for rails or guides in order to be adjusted or maintain their structure. As a result, they are compact and light, so don't become a hindrance to the landscape photographer who prefers to travel light.

The LEE Filters range of lens hoods can be used alone or in conjunction with filters, allowing the photographer to shade the lens and enhance their photographic composition at the same time.

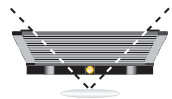

**Standard hood closed**



**Wideangle hood closed**



**Standard hood open**



**Wideangle hood open**

Thanks to their flexibility, these hoods can be used at varying angles, so can selectively shade parts of the image, or even match the movements of a large format camera – making them a versatile addition to the photographers' kit bag.

## ■ The universal hood

The Universal Hood is designed to suit the needs of most photographers. It works both as a simple lens shade, and in conjunction with filters. It comes assembled with two filter slots, but can also be configured to take different filter combinations. It is ideal for shading wideangle lenses on DSLR, 35mm SLR and medium format cameras.



## ■ The wideangle hood

The much larger bellows that are a characteristic of the Wideangle hood mean it can be used in conjunction with wide or very large lenses – reducing the chances of vignetting that would arise if a standard hood were to be used.

The Wideangle hood is also available in a slotted version. See page 18.



# □ Lens hoods

## ■ The standard hood

If a 2mm slot is fitted to the front of any LEE Filters holder, the holder is then compatible with the standard hood, which simply slots in and is ready for use. Alternatively, the hood can be fitted directly onto an adaptor ring.

Like the Universal and Wideangle hoods, the Standard hood is self-supporting, and is flexible and easily adjusted. For even more creative options, it is compatible with a set of guides which allow vignettes to be fitted to the front of the hood.



## ■ Slotted hoods

standard/wideangle

LEE Filters slotted hoods are designed to fit onto the lens via the adaptor ring (as opposed to the filter holder). The slotted hoods come in single (one filter) or double (two filters) options, with vignette guides as standard. The 2mm filter slots are situated immediately behind the bellows, while the hood itself has the same structure and flexibility as all others in the range.

Both standard and wideangle hoods are available with a slotted option; they are particularly suitable for social photographers who may require a hood holder combination.

# Filters



LEE Filters prides itself on the attention that is paid to the manufacture of each of its filters. It is for this reason that each filter is handmade to extremely precise detail by the skilled staff at the factory in Andover, Hampshire, England.

Each sheet of resin, polyester or glass is carefully inspected and, if any flaws are discovered, it is discarded. Once it has been cut to size, it is delivered to one of the technicians, who proceeds to dip it into the appropriate bath of dye. Neutral density filters are the most complex, requiring a level of precision that cannot be replicated by any piece of factory machinery.

A soft ND grad requires a gentle rocking and dipping action in the dye, so that the transition from the dyed part of the filter to the clear is as smooth as possible.

Hard ND grads, on the other hand, are created with a much sharper dipping action. Careful attention, of course, has to be paid to the point at which the transition occurs.

All filters are then checked in a spectrophotometer for colour density and evenness across the filter.

Only after the filter has undergone a strict process of quality control can it be packaged up for distribution to the company's network of dealers.

It is this attention to detail that ensures LEE Filters products are second to none.

# Filter choice

Whether you choose filters made from resin, polyester or glass, LEE Filters ensures the optical quality is second to none.

## Resin filters

Resin filters are made from lightweight, optically correct polymeric materials. This ensures they are durable, easy to handle – and can be wiped clean if sprayed by sea or sand during a shoot.

The filters are available as grads – where the top portion of the filter is coloured, and the lower portion is clear – or standard, where the whole filter is evenly coated in the colour or tone.

Resin filters are available either singly or in boxed sets, in sizes of either 100x150mm or 100x100mm. Sizes to fit other filter holder systems can be custom made. Because all LEE filters are handmade by skilled technicians, their quality is guaranteed.



## Polyester filters

Different light sources give off different colours, leading to casts in the end result. While this can be corrected in postproduction, for those who shoot film it is best resolved at the capture stage, and this is where LEE Filters' technical polyester filters enter the frame. Manufactured from the highest quality polyester-based material, the filters are tough and easy to clean. Polyester filters can be mounted in frames or cut to fit a photographer's existing system. All filter sets are supplied ready mounted for use with the LEE Filters holder system.

An ND standard range is also available in polyester, in strengths from 0.1 to 0.9, while other filters in the technical range include fluorescent correction, ultraviolet absorbing, infrared and colour compensating.

## Glass filters

A smaller range of filters is available in glass. These include ND standard filters, polarisers, star filters, a soft focus filter and an enhancing filter – which accentuates reds and oranges without affecting other colours.



## Hard graduated resin filters

A hard graduated filter is characterised by a very sharp transition between the coated and uncoated sections of the filter. A hard grad allows the photographer to control with great precision the desired effect on the composition – especially when the transition between two areas in the frame is particularly abrupt, as with a clear horizon, for example. The effect of the filter 'carrying over' from one part of the frame to another would be undesirable.

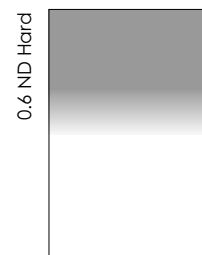

## Combination resin filters

These are graduated filters with a different colour at each end of the filter, and although this can be any combination of colours, it will most usually be an ND and a warm-up. The ND balances the exposure of the sky, and the warm-up gives a boost of colour to the foreground.

### Popular combinations are:

0.6ND to 81B or 81A, 0.75ND to Coral 2

These filters have separate colours top and bottom, and can only be made with hard grad transition.



## Soft graduated resin filters

The transition between the coated and uncoated portions of a soft graduated filter is less sharp and more subtle than in a hard grad. A soft grad is recommended when the variation in light readings within a scene is less pronounced, and on occasions when the effect of a hard grad would be apparent in the result, showing as a 'line' across the composition. The transition in tones, from bright to dark, should appear very natural when using a soft grad.



0.6ND with 81B, 0.6ND with 85C  
0.9ND with 81A

These filters have the warm-up over the entire filter, then an ND overdyed at one end. This gives a warming effect to both the sky and foreground, with the ND balancing the exposure. Available in hard or soft transition, with soft being popular for the darker colours.

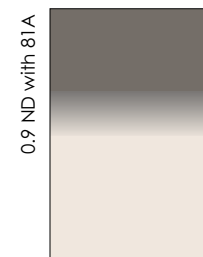

Combination filters are custom made and if used correctly, can yield impressive results.

# Neutral density graduated filters

Neutral density graduated filters

The purpose of the ND grad is to reduce the brightness of selected areas of the frame. Crucially, a true neutral density grad should have no impact on colour balance, and this is where LEE Filters' ND grads excel.

Neutral density grads are available in both hard and soft versions, and in strengths of 0.3, 0.45, 0.6, 0.75 and 0.9. The 0.3 strength equals one stop, while each subsequent increment equals an additional half-stop.

Therefore, if, for example, the sky in a scene were two-and-a-half stops brighter than the foreground, a 0.75 ND grad positioned across the sky without encroaching on the foreground would ensure an even exposure.

It is also possible to stack one ND grad on top of one another within the same holder – as long as there are sufficient filter guides to do so – for a variety of effects.

**Don't forget, neutral density graduated filters – as with most others in the LEE Filters range – are compatible with both digital and film photography.**

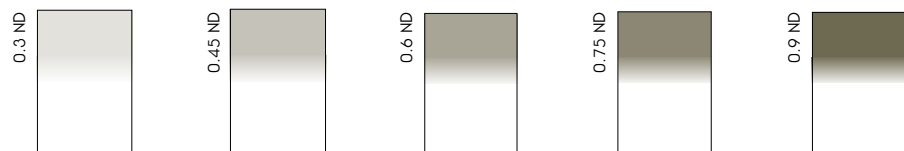

Filters Used

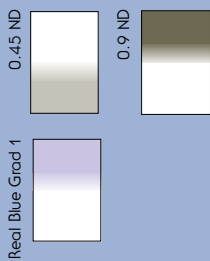

## Professional hint

Sometimes it might be necessary to sacrifice a certain amount of shadow detail when using ND grads. It is up to the photographer to visualise whether this loss is acceptable within the parameters of the image.

the System 22

# Neutral density standard filters



Neutral density standard filters

The aim of the standard ND filter is to reduce exposure equally across the entire frame. It is most commonly used to lengthen shutter speeds in order to blur the movement of, for example, clouds, water, or even people.

By stacking, say, a 0.6 ND filter on top, the exposure would be reduced by a further two stops, giving a reading of f/8 at 16 seconds.

**Professional hint**  
When reducing exposures significantly, don't forget to take reciprocity failure into account if shooting film.

An ND filter of 0.9 equates to a reduction of three stops. Therefore, a light reading (without filter attached) of f/8 at 1/2sec would become (with filter attached) f/8 at four seconds. In a case such as this, the effect of any movement would be quite pronounced.



# ProGlass neutral density standard filters



ProGlass filters

When shooting digitally, light at the infrared and ultraviolet ends of the spectrum can be problematic. The ProGlass range of filters has been designed with this in mind. These glass neutral density filters are optimised for use with digital cameras, as they absorb more infrared and ultraviolet light than traditional ND filters. The result is a punchier image, with less discoloration in adverse lighting conditions.

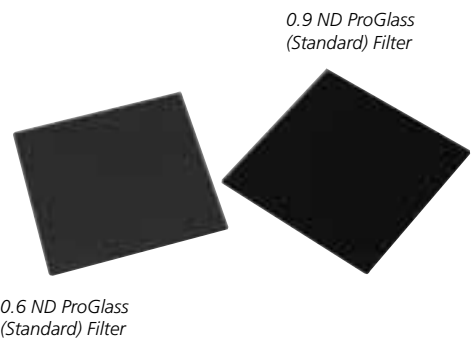

the System 23

# The polarising filter

The polarising filter is an invaluable tool in the photographer's armoury. Not only does it remove potentially distracting reflections from non-metallic surfaces such as glass and water, but it also increases colour saturation and deepens blue skies, making white clouds stand out in sharp relief.

Normally, light waves vibrate in all places at right angles to the direction of its travel. Polarised light, however, vibrates in only one plane. A polarising filter, therefore, allows through only those waves which vibrate in the plane parallel to the lines in the filter. By rotating the filter, certain waves pass through it, while others bounce off.

**It is this process of cutting out certain waves of light from reflected surfaces that makes colours appear more saturated.**

In addition, because much of the light in the sky on a clear, sunny day is polarised, the polarising filter removes these waves, hence the appearance of a deeper, stronger blue in the final image.

The effect of a polarising filter on a scene can be assessed in two ways. If using an SLR, simply attach the filter to the front of the lens, look through the viewfinder, and rotate the polariser until the desired effect is achieved. Alternatively, if using a rangefinder, where its strength cannot be assessed by looking

through the lens, hold the filter up to the scene, rotate it until the desired effect is achieved, then place it on the camera's lens.

## Linear and circular

**There are two types of polarising filter: linear and circular. These terms do not refer to the shape of the filter, but rather the way in which the filter modifies the light waves that pass through it.** The type of filter required depends on the camera.

If you use an autofocus SLR (digital or 35mm) in, for example, spotmetering mode, you will need a circular polariser. This is because a linear polariser will interfere with the complex metering and AF systems of modern cameras.

If you use a manual focus camera, whether 35mm or medium format, you can use either a circular or a linear polariser.

If you are still unsure of the type of polariser you require, check your camera's instruction manual.

**A polarising filter will increase your exposure by 1<sup>2</sup>/<sub>3</sub> stops.**

LEE Filters produces both types of polariser in two versions: a rotating 105mm-diameter version, and a 100x100mm square version.



## The 105mm rotating polariser

This polariser is attached to the filter system by a special ring, which fits to the front of the filter holder. This allows the polariser to be rotated independently of any other filters in the holder. It is the ideal solution for landscape photography, where a combination of graduated filters and polariser may be required.

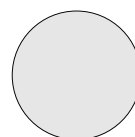

105mm rotating polariser – circular and linear

## The 100x100mm square polariser

This polariser slots into the filter holder, which is then rotated to achieve the desired effect. This version is recommended for studio use, or when no filters are required in addition to the polariser.



100x100mm square polariser – circular and linear

**Polarising filters can be used with both digital and film cameras.**

Unfiltered



## Professional hint

If using a polarising filter in conjunction with polyester filters, the polariser must be placed *in front of* the polyester filters, not behind, otherwise it will not function correctly. This problem does not arise when the polarising filter is used in conjunction with resin filters.

Filtered



## Professional hint

Sometimes a fully polarised sky can appear overdone. Experiment with halting the rotation at around 45 degrees to the sun, rather than the full 90 degrees, for a more natural-looking result.



# Resin sets

Resin sets

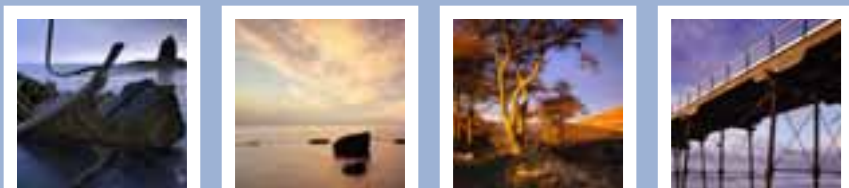

The LEE Filters Effects Sets are the best – and most economical – way of introducing filters into your photography. From the classics, such as the ND Grad Set and Sunrise Set, to the unusual, such as the Selective Star and Net Set – every creative eventuality has been catered for.

Each set is presented in a filter wrap. Designed to hold three filters, the wrap can be folded and slipped into a camera bag or pocket. It takes up minimal space, while making the filters easy to select when needed quickly.

Effects Filters aren't restricted to use on their own, either. Any different effect can be combined; the limitations are only the number of filter guides in the holder – and the photographer's imagination!

## Sizes

All resin sets are 100x150mm graduated filters. Please note that standard resin filters are currently not available in sets.

## Section contents

- 27 Neutral density set
- 28 Sky set
  - Autumn tint set
- 29 Sunrise set
  - Landscape set
- 30 Sky blue set
  - Coral set
- 31 Sunser set
  - Twilight set
  - Colour grad set
- 32 Pale tint set
  - Pop set
  - Stripe set
- 33 Mist set
  - Selective star set
  - Net set

# Neutral density grad set



Neutral density grad set

The Neutral Density Grad Set is suitable for use with both digital and film cameras, and features three neutral density graduated filters of 0.3, 0.6 and 0.9 strengths (equating to a reduction of one, two and three stops respectively).

If the sky is one stop brighter than the foreground, a 0.3 ND grad would be used; two stops, and a 0.6 ND grad would be used – and so on. Grads can be stacked one on top of the other, or combined with different effects grads, for even more creative photographs.

The beauty of the ND grad is that it allows the photographer to reduce exposure in one part of the scene, while leaving the rest unaffected.

**And because LEE Filters ND grads are truly neutral, there will be no nasty colour casts on the end result.**

Neutral density grads are most commonly used when the sky is brighter than the foreground. By placing an ND grad across the bright area, detail is retained and a more balance composition is the result.

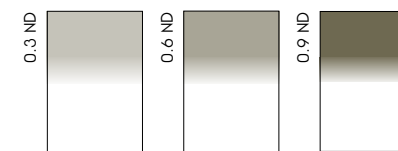

Filtered



Unfiltered



Filters Used



# Sky set

Sky set

The purpose of the Sky Set is to enhance the colours in the sky, and is particularly useful when a sunrise or sunset hasn't quite lived up to expectations. The Sunset 2 enhances warm tones, typical of the light at the end of the day, the Sky Blue 3 introduces colour into lifeless skies, while the Coral Stripe boosts a selective area of the frame – usually directly above the horizon.

### Contains:

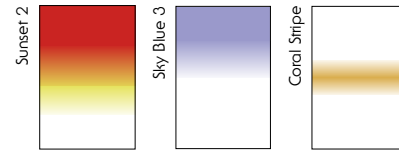

Filtered



Unfiltered

### Filters Used

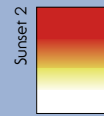

### Contains:

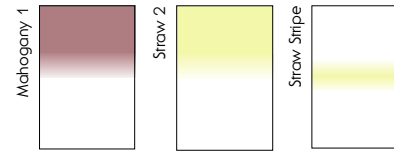

# Sunrise set

Sunrise set

The light at dawn tends to be rather paler and more subtle than at sunset, and this set reflects this. The strong yellow of the Straw 2 acts as a warm-up, while the Mahogany 1 is suitable for creating a paler effect. The Straw Stripe introduces warmth into the horizon.

Sunrise set



Filtered



Unfiltered

### Filters Used



# Autumn tint set

Autumn tint set

The Autumn Tint Set, as the name suggests, is particularly suitable for enhancing the colours in autumnal scenes, making the most of the rich golds, reds and browns that typify the season.

A unique feature of these filters is that they can be used as both hard grads and standards. Because the graduation line is placed 90mm from the top of the filter, the coated portion of the filter is sufficient to cover the whole scene. Alternatively, by raising the filter higher in its holder, it then becomes a grad.

### Contains:

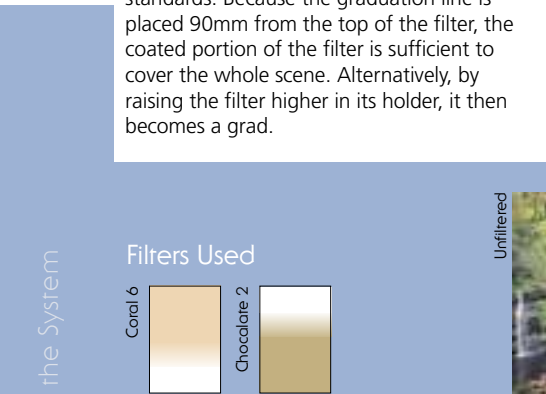
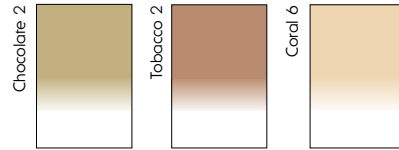

Unfiltered

### Filters Used

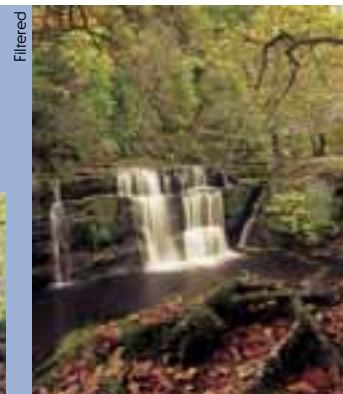

Filtered

### Contains:

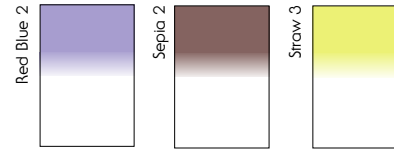

# Landscape set

Landscape set

This set is designed to complement the landscape – be it urban or rural. The Real Blue 2 brings intensity to faded skies, while an inverted Straw 3 warms the foreground. Suitable for more classic landscapes, the Sepia 2 enhances the colour of rocks, foliage and fallen leaves.

Landscape set



Filtered



Unfiltered

### Filters Used

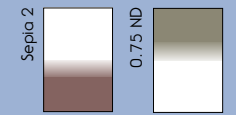

# Sky blue set

Sky blue set

Lifeless skies in both land and seascapes can be enhanced with the subtle use of this set, with each filter increasing slightly in intensity.

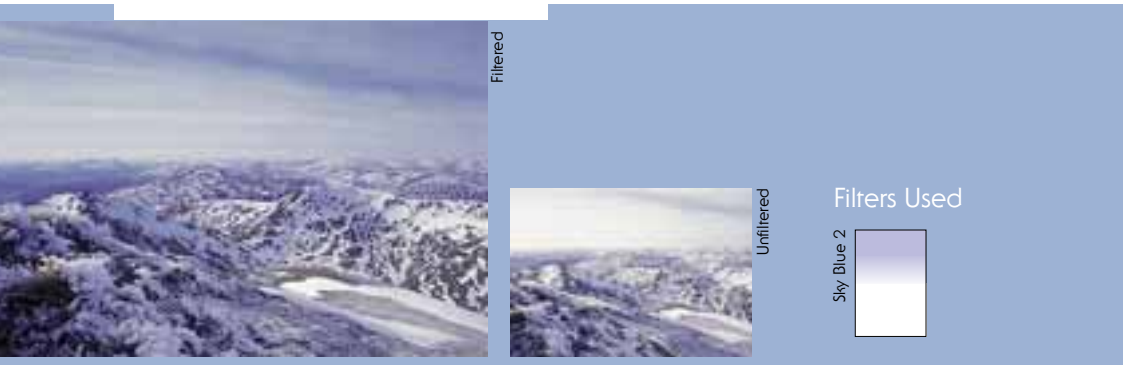
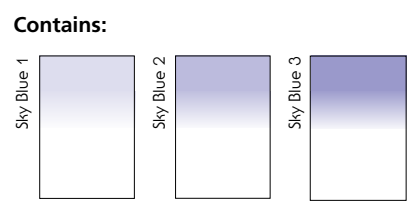

# Coral set

Coral set

The Coral set – which ranges in strength from pale to mid tone – has a variety of uses. When placed across the sky, a warm, soft orange hue is introduced; when inverted it brings tone to greenery in the foreground. The higher the number in the Coral grad series, the further the colour temperature is corrected.

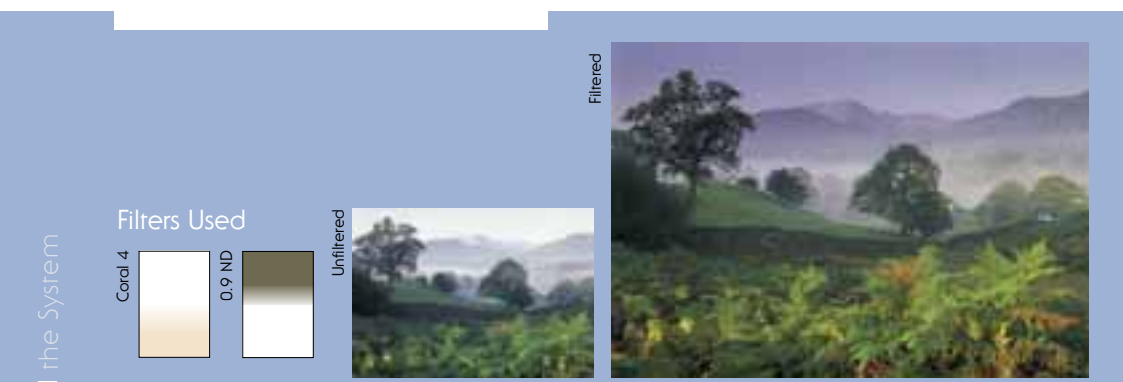
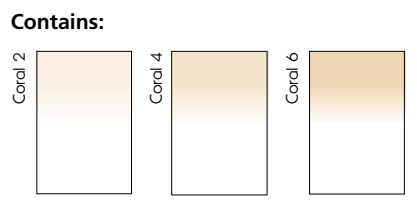

the System

# Sunset set

Sunset set

This popular set adds warmth and definition to both sky and landscape, enhancing the natural colours created by sunsets. The extra-deep coating of the Sunset Yellow filter allows it to be used both as a standard and a grad.

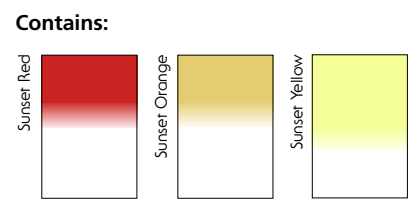

# Twilight set

Twilight set

Not to be confused with the Coral Stripe, this pale version permits a subtler approach to the enhancement of the horizon. When used in conjunction with the Mahogany 3, which gives the impression of a 'red sky at night', the effects can be striking. The Twilight filter replicates the deep blue that arises when day crosses into night.

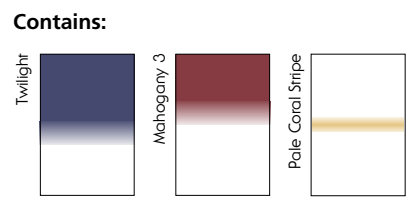

# Colour grad set

Colour grad set

This set is particularly effective at introducing special effects, by colouring just one section of the frame. By combining two or more filters in the same holder, the colours of red, blue and green can be created. And their versatility doesn't stop there. One filter can be placed to cover the top of the frame, while another can cover the lower part. For example, using the Cyan filter to enhance the sky, and the Yellow filter to warm the foreground.

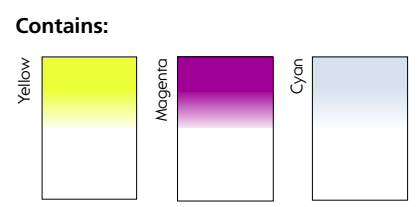

the System

## Pale tint set

The number one denotes that each of these filters is the palest of its range. The colours in this set allow the photographer to introduce the subtlest hints of tone to selected parts of the image.

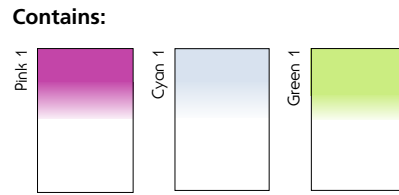

## Pop set

**Contains:**

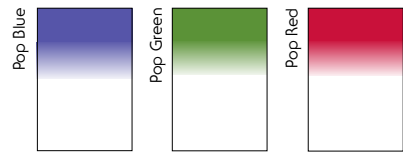

The primary colours of red, green and blue form the basis of this set. Like a more intense version of the Colour Grad Set, it can be used creatively to introduce colour into selected areas of the frame. Like other grads, their position can be altered both by rotating the holder, and sliding up and down within the filter guides.

## Stripe set

The stripe that characterises this set can be placed anywhere within the frame, from bottom to top. Additionally, the stripe can be placed horizontally or at an angle, depending on the rotation of the holder. The colours are ideal for creating special effects.

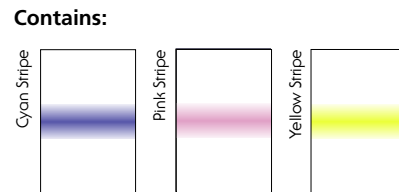

### Professional hint

When using striped filters, careful consideration of aperture is important. The smaller the aperture, the more apparent the transition from colour to clear.

## Mist set

**Contains:**

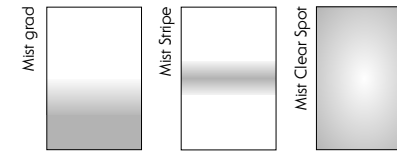

The filters in this set are designed to imitate the effects of fog and mist, and are suitable for use either alone or in combination with one another – depending on the desired density. The Stripe, when used in the foreground, gives a sense of the depth of fog, while the Clear Spot takes the viewer's eye straight to the most important part of the frame – wherever the photographer decides that may be.

## Selective star set

With careful positioning of these filters, a star pattern is introduced into the highlight areas of the photograph. The Star Segment creates stars in a chosen segment of the frame. Finally, the Star Graduate features highlights in one portion of the filter, which gradually fade to clear.

**Contains:**

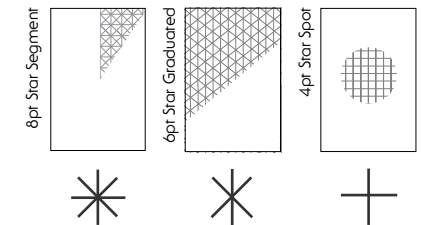

## Net set

**Contains:**

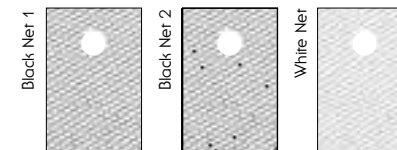

Based on the type of net filter which is commonly used in cinematography, this set creates a subtle soft focus effect. Additionally, the black net filters increase contrast, while the white net filters decrease it. The filters can be moved up and down within the holder to control where the clear spot appears in the photograph. When using the Black Net 1, exposure should be increased by half a stop. When using the Black Net 2, exposure should be increased by one stop.

# Soft focus filters

## Glass soft focus filter

The LEE Glass Soft Focus filter offers the photographer the option of softening the scene, without the result appearing to be overdone. Crucially, overall contrast is almost unaffected, and altering the aperture or focal length has no adverse effect on the resulting photograph. The LEE Glass Soft Focus filter measures 100x100x2mm.

## Landscape

Although it might not be the first filter a photographer reaches for when shooting landscapes, the soft focus filter can still prove invaluable on occasion. **Used in the right circumstances, its effect can be pleasing and unusual.**

The soft focus filter is particularly suitable for use when shooting landscapes with telephoto lenses – especially at wide apertures for a limited depth of field. In situations such as these, the main subject remains sharp while the foreground and background are thrown out of focus. By bringing a soft focus filter into the equation, any sharp sidelight is very slightly dispersed, injecting a warm, ethereal atmosphere into the image that, in many ways, simply enhances what is already there.

## Portrait

The soft focus filter is an indispensable addition to any portrait photographer's kit. **The gentle, flattering results are attractive without being overpowering,** and are particularly aesthetically pleasing when the filter is used in high key lighting set-ups.

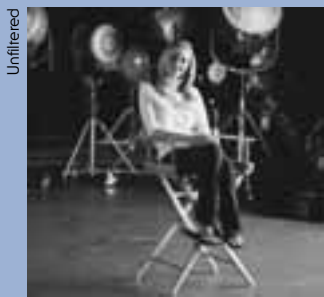

Unfiltered



Filtered

# Soft set



Five filters of increasing strengths make up the LEE Filters Soft Set. Number one is the most subtle effect, and is barely noticeable, while number five produces a very heavy diffusion.

Made from the highest quality, optically correct polyester-based materials, these lightweight and inexpensive filters are perfectly suited to all types of portraiture and social photography.

The Soft Set is suitable for use with both digital and film cameras, and affords the photographer complete control over the image, with no need for image manipulation programmes.

The Soft Set is supplied ready-mounted, for added protection, and is compatible with the LEE Filters holder system.

## Professional hint

The stronger filters – 4 and 5 – work effectively with wideangle lenses, while the weaker versions – 2 and 3 – are often all that is needed when using a longer focal length.

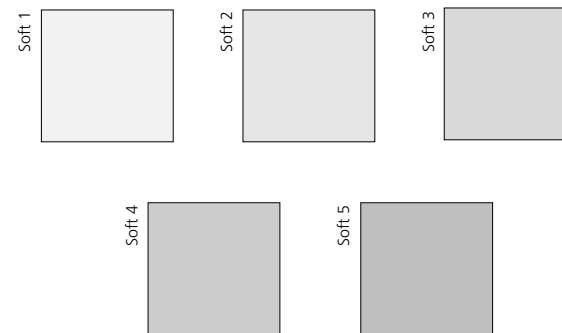

# Glass enhancer

This unusual filter enhances any red or orange features within the frame, leaving other colours unaffected.

The Glass Enhancer is particularly effective when shooting natural landscapes that may require a boost. Autumnal colours are rendered deep and rich, while sunsets and any warmly coloured elements stand out from the objects around them. The filter is also suitable for use with certain architectural images.

The best way to assess whether the Glass Enhancer is suitable for any given image, is simply to hold it up and view the scene through the filter.

**Use of the Glass Enhancer requires an increase in exposure of one stop.**



Unfiltered



Filtered



100 x 100mm enhancer

# Single effects filters

## Red

For colour effects.



## Sunset Red

The red portion of the Sunset Grad.

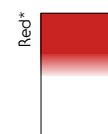

## Sunsets

For a sunset effect when shooting into a low sun.

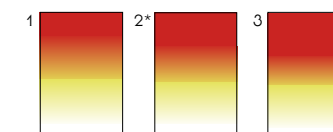

## Yellow

For colour effects.



## Sunset Yellow

The yellow portion of the sunset grad.

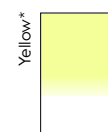

## Straw

For a strong warm-up effect when shooting landscapes; accentuates foregrounds when inverted.

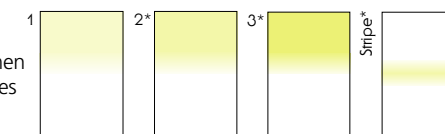

## Sunset Orange

The orange portion of the Sunset Grad.

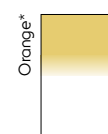

## Pale Coral

Paler and narrower than the Coral Stripe for a more subtle effect.

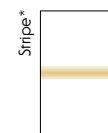

\* filter available both individually and as part of a set

# Single effects filters

## Coral

Slightly pink warm-up filter, more red than 81 series.

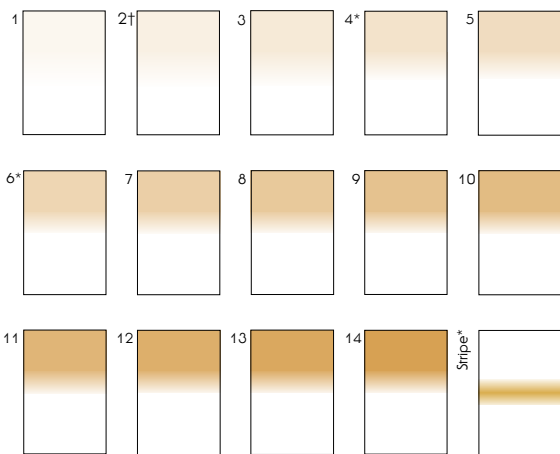

## Chocolate

Accentuates brown tones, such as autumn leaves and stone.

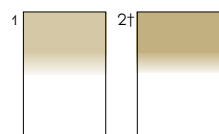

## Tobacco

Darker and more red than Chocolate and Sepia filters, with a very strong effect.

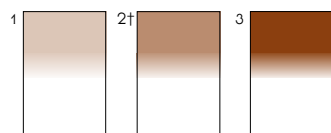

## Sepia

For a brown-tinted monochrome appearance, which is less red than Chocolate.

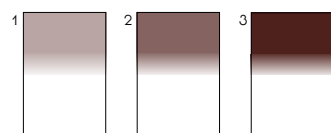

## Green

For colour effects.

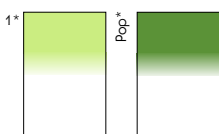

## Blue

A deep red-blue, mainly for colour effects.

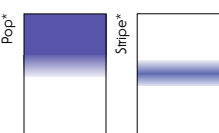

\* available as part of a set. † filter in the set is an extended graduated version.

## Real Blue

Darker and more black than Sky Blue, for a stronger impact on skies.

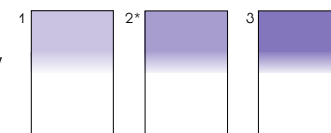

## Sky Blue

A green-blue to bring realistic colour into flat skies.

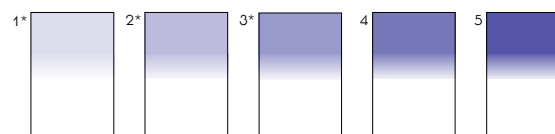

## Cyan

For colour effects.

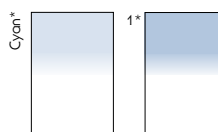

## Twilight

Deep blue-black gives a monochromatic twilight appearance.

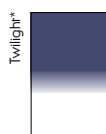

## Mahogany

Enhances impression of dawn and evening light in skies; 'red sky at night' effect.

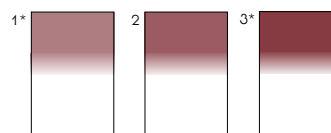

## Magenta

For colour effects.

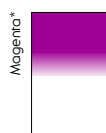

## Pink

For colour effects.

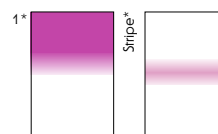

\* available as part of a set. † filter in the set is an extended graduated version.

# Single effects filters

## Neutral Density

Reduces exposure in selected areas without affecting colour balance.

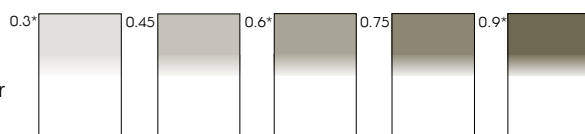

### Professional hint

When using neutral density grads in conjunction with a DSLR, consider attaching one of a stop less than that suggested by the light reading (e.g. 0.6 instead of 0.9). This is so maximum detail is recorded in the scene, which can later be adjusted in postproduction.

## Fog

For an opaque, misty effect, which is different from soft focus.



## Low Contrast

A slight white opacity, to lighten darker areas and so reduce contrast.



## Mist

Introduces a misty effect to selected areas of the frame.

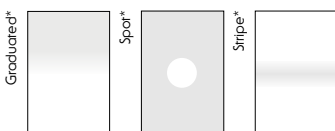

## Ner

A subtle, soft-focus effect, with hole for a clear centre, if required.

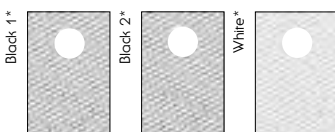

## Star

Precision manufacturing process achieves a clear yet subtle star effect.

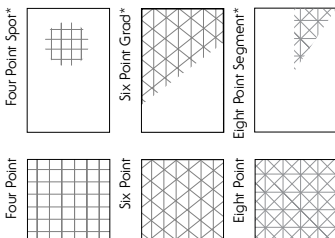

\* filter available both individually and as part of a set

# Technical filters



Most filters in this range are manufactured from the highest quality polyester base, which is tough and durable, as well as being impervious to water and easy to clean. **Because of the high quality of the material used, the optical quality of LEE Filters' polyester range is equal to that of its resin and glass filters.**

The filters in this range are designed to tackle specific problems, such as correcting colour temperature – whether major or minor – or absorbing light that would otherwise create unwanted casts. The Black & White Set allows the photographer to adjust certain tones within the frame, while the Soft Set introduces increasing levels of diffusion.

## Section contents

- 42 Colour temperature set
  - Warm-up set
  - Daylight fluorescent set
  - Tungsten fluorescent set
- 43 Neutral density set
  - Magenta set
  - Soft set
- 44 Colour temperature adjustment filters
- 45 Neutral density filters
- 46 Fluorescent correction filters
  - Ultraviolet absorbing filters
- 47 Colour compensating filters
  - Infrared
- 48 Filters for black & white photography

# Polyester technical sets

## Colour temperature set

This four-filter set is designed to balance the effect of any major colour temperature disparities between light source and film or sensor. This avoids the appearance of colour casts on the final image.

filter	conversion	approx exposure increase	mired shift
85B	5500K to 3200K	2/3 stop	+131
85C	5500K to 3800K	2/3 stop	+81
80C	3800K to 5500K	1 stop	-81
80A	3200K to 5500K	2 stops	-131

## Fine colour temperature set

Similar to the Colour Temperature Set, above, this set is designed to tackle less extreme colour shifts. It can also be used to introduce subtle warming or cooling effects to the final image.

filter	conversion	approx exposure increase	mired shift
81D	3700K to 3200K	2/3 stop	+42
81A	3400K to 3200K	1/3 stop	+18
82A	3000K to 3200K	1/3 stop	-21
82C	2800K to 3200K	2/3 stop	-45

## Warm up set

Four filters of increasing intensity, primarily used for introducing warmth into both landscapes and portraits.

filter	conversion	approx exposure increase	mired shift
81	3300K to 3200K	1/3 stop	+9
81B	3500K to 3200K	1/3 stop	+27
81D	3700K to 3200K	2/3 stop	+42
85C	5500K to 3800K	2/3 stop	+81

## Daylight fluorescent set

This set of filters ensures – when shooting daylight-balanced film under fluorescent light – that the result is neutral. In addition, there is a range of lighting filters that balances flashlight, too. These are essential because all light entering the camera must be of the same spectral output as the fluorescent source, if the result is to be corrected accurately.

filter	function	approx exposure increase	flash
FL3600-D	Balances warm-white tubes	1 2/3 stops	1/2 CTO + Plus Green
FL4300-D	Balances white tubes	1 stop	1/4 CTO + Plus Green
FL5700-D	Balances daylight/cool white tubes	2/3 stop	Plus Green

## Tungsten fluorescent set

A three-filter set to allow for shooting under fluorescent lighting when shooting tungsten-balanced film. As with the Daylight Fluorescent Set, there is a range of filters to place over a flashgun.

filter	function	approx exposure increase	flash
FL3600-B	Balances warm-white tubes	2/3 stop	1/2 CTO + Plus Green
FL4300-B	Balances white tubes	1 stop	1/4 CTO + Plus Green
FL5700-B	Balances daylight/cool white tubes	1 1/3 stops	Plus Green

## Neutral density set

The three filters in this set are designed to increase exposure without affecting the colour balance of the picture. They are compatible with all standard film types, and digital sensors.

filter	colour	approx exposure increase
0.3 ND	neutral density	1 stop
0.6 ND	neutral density	2 stops
0.9 ND	neutral density	3 stops

## Black and white set

Four filters, each of which has a different effect on the tones in a black & white image by absorbing different quantities of colour in the blue and blue-green parts of the spectrum. These filters also can be used for special effects.

filter	colour	approx exposure increase
8	Yellow	1/3 stop
11	Yellow Green	1 1/3 stops
21	Orange	1 stop
23a	Light Red	2 stops

## Magenta set

Five CC Magenta filters, which are designed to absorb the green cast created by fluorescent lighting. They can be stacked one on top of another for greater absorption, and used in conjunction with colour temperature filters for complete accuracy in colour balance.

filter	colour	approx exposure increase
CC05M	Magenta	1/3 stop
CC10M	Magenta	1/3 stop
CC20M	Magenta	2/3 stop
CC25M	Magenta	2/3 stop
CC30M	Magenta	2/3 stop

## Soft set

Five filters, each of which gradually increases in soft-focus effect. This set is particularly suitable for landscape and portrait photography, when a diffused, romantic result is desired. The soft effect is virtually unaffected by variations in aperture and focal length.

filter	type	approx exposure increase
Lee Soft 1	Light soft focus	not required
Lee Soft 2	Soft focus	" "
Lee Soft 3	Soft focus	" "
Lee Soft 4	Soft focus	" "
Lee Soft 5	Strong soft focus	" "

## Colour temperature adjustment filters

These filters have a variety of uses. Although designed to convert the colour characteristics of a light source to balance with the film type in use, they can also be used deliberately to create a warm or cool overall colour cast.

description	filter	approx exposure increase	conversion	mired shift	resin grad	resin standard	polyester standard
Blue for major adjustment	80A	2	3200K to 5500K	-131	✓	✓	✓
	80B	1 2/3	3400K to 5500K	-112	✓	✓	✓
	80C	1	3800K to 5500K	-81	✓	✓	✓
	80D	2/3	4200K to 5500K	-56	✓	✓	✓
Pale Blue for fine adjustment	82C	2/3	2800K to 3200K	-45	✓	✓	✓
	82B	2/3	2900K to 3200K	-32	✓	✓	✓
	82A	1/3	3000K to 3200K	-21	✓	✓	✓
	82	1/3	3100K to 3200K	-10	✓	✓	✓
Pale Amber for fine adjustment	81	1/3	3300K to 3200K	+9	✓	✓	✓
	81A	1/3	3400K to 3200K	+18	✓	✓	✓
	81B	1/3	3500K to 3200K	+27	✓	✓	✓
	81C	1/3	3600K to 3200K	+35	✓	✓	✓
	81D	2/3	3700K to 3200K	+42	✓	✓	✓
81EF	2/3	3850K to 3200K	+53	✓	✓	✓	
Amber for major adjustment	85C	2/3	5500K to 3800K	+81	✓	✓	✓
	85	2/3	5500K to 3400K	+112	✓	✓	✓
	85B	2/3	5500K to 3200K	+131	✓	✓	✓

(mired shift can be negative as well as positive)

## Neutral density filters (ND)

Neutral density filters reduce light transmission uniformly across the visible region of the spectrum, in incremental steps. Although used mainly in colour photography for reducing light levels without altering the colour of the image, they can also be used in black & white photography. ND filters are particularly useful for compensating for too much light, in circumstances where altering shutter speed, aperture or film speed is not possible or desirable.

Additionally, ND filters can be used creatively to extend shutter speed times when shooting, for example, running water or waterfalls – without adjusting the aperture. Alternatively, the use of an ND filter allows the photographer to increase their aperture by the stop value of the filter used. For example, if a reading suggests an aperture of f/8, but the desired aperture is f/4, the addition of a 0.6 ND filter permits the photographer to open up to f/4.

neutral density	stop value	transmission %	resin grad	resin standard	polyester standard	glass standard
0.1	1/3	79.4			✓	
0.2	2/3	63.1			✓	
0.3	1	50.0	✓	✓	✓	
0.4	1 1/3	39.8			✓	
0.45	1 1/2	37.5	✓	✓		
0.5	1 2/3	31.6			✓	
0.6	2	25.0	✓	✓	✓	✓
0.7	2 1/3	19.6			✓	
0.75	2 1/2	18.75	✓	✓		
0.8	2 2/3	15.9		✓		
0.9	3	12.5	✓	✓	✓	✓

## Combination filters (Comb)

This range of filters which combines the characteristics of ND filters with selected colour temperature adjustments.

CT/ND combination	approx exposure increase	conversion	mired shift	resin standard	polyester standard
85BN3, 85BN6, 85BN9	1 2/3, 2 2/3, 3 2/3	5500K to 3200K	+131	✓	✓
85N3, 85N6, 85N9	1 2/3, 2 2/3, 3 2/3	5500K to 3400K	+112	✓	✓
81EFN3, 81EFN6, 81EFN9	1 2/3, 2 2/3, 3 2/3	3850K to 3200K	+53	✓	✓

# Colour control

Colour control

## Fluorescent correction filters (CC/CT)

This system combines colour temperature conversions and green absorption into one filter, making it suitable for use in various fluorescent-lit conditions. The selection of filter depends on the film in use and the type of fluorescent light.

film type	filter	approx exposure increase	light source	resin standard	polyester standard
Tungsten (3200K)	FL 5700-B	1 1/3 stops	Cool White 5700K	✓	✓
	FL 4300-B	1 stop	White 4300K	✓	✓
Daylight (5500K)	FL 3600-B	2/3 stop	Warm White 3600K	✓	✓
	FL 5700-D	2/3 stop	Cool White 5700K	✓	✓
	FL 4300-D	1 stop	White 4300K	✓	✓
	FL 3600-D	1 2/3 stops	Warm White 3600K	✓	✓

## Arc correction filters (CC/CT)

These filters are designed to correct colour balance under mercury vapour or high pressure sodium lighting. There are versions for both daylight and tungsten-balanced film.

film type	filter	approx exposure increase	light source	resin standard	polyester standard
Tungsten (3200K)	HPS-B	2 stops	High Pressure Sodium	✓	✓
	MV-B	2 stops	Mercury Vapour	✓	✓
Daylight (5500K)	HPS-D	3 stops	High Pressure Sodium	✓	✓
	MV-D	2 2/3 stops	Mercury Vapour	✓	✓

## Ultraviolet absorbing filters (CC/CT)

This range of filters absorbs varying degrees of ultraviolet radiation, which is the cause of haze and bluish casts in distant landscapes, water scenes and aerial photography.

filter	description	resin standard	polyester standard
1A	Maximum absorption of 0.076A (84%) at 535 nanometres	✓	✓
1B	Maximum absorption of 0.086A (82%) at 525 nanometres	✓	✓
2B	UV Absorption greater than 0.72A (19%) at 400 nanometres	✓	✓
2C	UV Absorption greater than 0.39A (40.5%) at 400 nanometres	✓	✓

## Colour compensating filters (CC/CT)

The filters in this range can be used either in front of or behind the lens, and reduce the transmission of light at specific wavelengths. Their primary use is to colour balance films; however, the effect of each filter must be determined by tests, or specified by the film manufacturer. They are also useful for correcting light sources for which no standard conversion filter exists, or for introducing a deliberate colour bias.

	025	05	10	15	20	25	30	40	50		resin grad	resin standard	polyester standard
<b>Cyan</b>	Nil	1/3	1/3	1/3	1/3	1/3	2/3	2/3	2/3	Principally absorbs Red	✓	✓	✓
<b>Yellow</b>	Nil	Nil	1/3	1/3	1/3	1/3	1/3	1/3	1/3	Principally absorbs Blue	✓	✓	✓
<b>Magenta</b>	Nil	1/3	1/3	1/3	2/3	2/3	2/3	1	1	Principally absorbs Green	✓	✓	✓
<b>Red</b>	Nil	1/3	1/3	1/3	2/3	2/3	2/3	1	1	Principally absorbs Blue & Green	✓	✓	✓
<b>Green</b>	Nil	1/3	1/3	1/3	1/3	1/3	2/3	2/3		Principally absorbs Blue & Red	✓	✓	✓
<b>Blue</b>	Nil	1/3	1/3	1/3	2/3	1	1 1/3	1 1/3	1 2/3	Principally absorbs Red & Green	✓	✓	✓

The values shown are the suggested exposure increase for each filter.

## Tricolour filters (TR)

colour	filter	description	approx exposure increase	resin standard	polyester standard
Tricolour Red	25	Separation filter. Maximum transmission above 610 nanometres. Also used for black and white contrast effects, haze penetration in aerial photography, and removing blue in infrared photography	2 1/2 to 3 stops		✓
Tricolour Blue	47B	Separation filter. Maximum transmission at 440 nanometres	2 1/2 to 3 stops		✓
Tricolour Green	58	Separation filter. Maximum transmission at 530 nanometres	2 1/2 to 3 stops		✓

## Infrared (IR)

colour	filter	description	resin standard	polyester standard
Infra-Red	87	This visually opaque filter is used in infrared photography to absorb unwanted visible light. Transmission begins above 730 nanometres.		✓

Colour control

the System

# Colour control

## Filters for black and white (CC/CT) photography

Filters are widely used by black & white photographers for creative effect – most commonly to increase contrast between sky and cloud. However, care should be taken, because as much as a black & white filter darkens one colour, it lightens another – specifically, any colour that is similar to its own. A red filter, for example, makes a red pillar box appear almost white, and a blue sky as almost black. However, a red filter also absorbs green, which would block up the foreground of a verdant landscape.

The black & white filters in the LEE Filters range can be used in conjunction with others, such as the polariser and neutral density standards and graduates.

### Professional hint

Don't always reach automatically for the red filter to enhance a sky. The results obtained from its orange or yellow counterparts can be just as pleasing in their subtlety and, if desired, the sky can be burned in later – either in the darkroom or in postproduction.

colour	filter	description	approx exposure increase	resin grad	resin standard	polyester standard
Light Yellow	3	Partially corrects for excess blue in aerial photography.	none	✓	✓	✓
Yellow	8	Darkens sky, cloud and foliage to reproduce correct tones.	+1/3	✓	✓	✓
Yellowish - Green	11	Used to alter the response of panchromatic emulsions, to be equivalent to the natural response of the eye to objects under tungsten illumination. Greens are reproduced slightly lighter in daylight.	+1 1/3	✓	✓	✓
Deep Yellow	12	Minus blue filter. Can be used to cancel blue light when infrared-sensitive films are exposed. Also penetration of haze during aerial photography.	+1/3	✓	✓	✓
Deep Yellow	15	Increases contrast between cloud and sky greater than No.8, for over-correction effect. Also used for copying documents on yellowed paper.	+2/3	✓	✓	✓
Yellow Orange	16	Gives even greater over-correction than No.15. Absorbs a small amount of green.	+2/3	✓	✓	✓
Orange	21	Contrast filter. Absorbs blue and blue/green.	+1	✓	✓	✓
Light Red	23A	Greater contrast effect than No.21.	+2	✓	✓	✓

This sequence demonstrates how different colours are affected by different filters.

Light yellow 3



Darkens blue tones

Yellow/green 11



Lightens greens/darken reds

Unfiltered



Unfiltered



Orange 21



Lightens reds/darkens some blue and blue/green

Light red 23 A



Dramatically lightens reds and darkens blue and green

# Accessories

The accessories range is designed to make use of the LEE Filters system quick and even more straightforward.



## Gelsnap

The Gelsnap a low-cost holder, suitable for use with both mounted and unmounted filters, and can be attached to the front of almost any camera set-up. It's particularly popular with toy camera aficionados but – at the opposite end of the scale – is also compatible with large format cameras, where it can be placed behind the lens.

Simply slot any 100mm polyester filter into the Gelsnap, close it, and it is ready to be attached to the lens using the band provided.

## System accessories

The range of products compatible with the LEE Filters system includes:

- **Tandem adaptors**
- **Mounts**  
To permit the use of 84mm filters – both square and rectangular – within the LEE Filters system.
- **Mounts**  
For polyester filters – both 75x75mm and 100x100mm.
- **Holder guides**  
Guides for using extra filters.
- **Screws**  
Of varying lengths.
- **Filter cleaning solution**  
For use on resin and glass filters.



- **Cleaning cloth**  
A high quality cleaning cloth which can be used either dry or with the cleaning solution.
- **Lens cap**  
The lens cap allows you to leave the adaptor ring attached at all times while keeping the front element clean and safe. They are made of white polypropylene and, when attached, can be used to white balance a digital SLR, or as a makeshift incident lightmeter on any camera. They can also be written on to identify lenses in the camera bag.
- **Rangefinder face blades**  
These calibrated metal face blades simply replace the existing front blades on the Standard LEE Filter holder, enabling quick and consistent positioning for graduated filters when used on rangefinder cameras.



## Accessories



### Multi-filter pouch

For simple storage of filters, not to mention quick and easy access when on a shoot, the Multi-filter Pouch holds up to 10 filters.



### Leather filter pouch

This smart, hardwearing pouch, made from high quality leather, holds up to six filters and is designed for quick selection of filters when on location. The pouch slips easily into the camera bag, and can be attached to a belt so that filters are always close to hand and easily attached in fast-changing lighting conditions.



### The Tri-pouch

The Tri-pouch is manufactured from the same tough fabric as standard single pouches, but holds three filters instead of just one – allowing photographers to pack their preferred resin set when heading out on location. The pockets are also wide enough to carry holders and adaptor rings. The pouch features belt loops on the back.



### Filter wrap

The Filter Wrap is a simple, yet ingenious design. Made from a microfibre cleaning cloth, it holds up to three filters and can be folded and stored, using only minimal space.

## The RF75 filter system

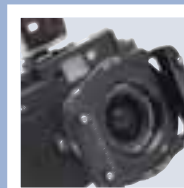
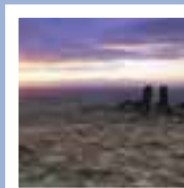

Many photographers, despite the onset of the digital revolution, still appreciate the compact structure and high quality lenses associated with rangefinder camera systems. However, the size of filters in holders has always been something of a problem, blocking part of the viewfinder and sometimes even restricting the taking of light readings. Now, there is a solution. The RF75 system from LEE Filters is a high quality precision filter holder that is compact, lightweight and designed to fit lenses with a diameter of 67mm or less.

The holder will benefit users of rangefinder and high end digital compact cameras, but will equally be of use for large and medium format users who require a smaller, more compact filter system.

# The RF75 filter system

The idea behind the RF75 system was to have a smaller filter and holder, which would allow the viewfinder to be free of obstructions when positioned on the lens. As a result, framing adjustments can be made once the filter system is in place. The smaller size means less weight, which suits the type of camera on which it will be used.



The front of the filter holder features laser-etched markings, which correspond to fractions of the frame. For example, the first mark above the holder's centre line corresponds to approximately one third of a 35mm frame (see diagram).

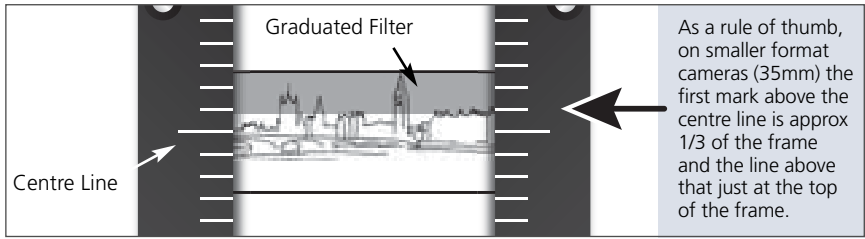

The line above that marks the top of the frame. As a result, **accurate positioning of the filter is possible even when the effect cannot be viewed through the lens.** Equally importantly, it is quick to use, allowing the photographer to respond to rapidly changing conditions.

Like all LEE Filters products, the RF75 system is equally at home on film and digital cameras. Above all, it has been designed by photographers for photographers.



The RF75 system features its own circular polarising filter. The unique clip-on design means it can be snapped onto the front of the holder and rotated independently of any graduated filters also in use. Aside from the polariser, the system includes a full range of resin and some glass filters, which are sized at 75x90mm.



Polariser

The holder has been designed so that it is compatible with some of the widest angle lenses, allowing them to be used in conjunction with at least one filter and a polariser.

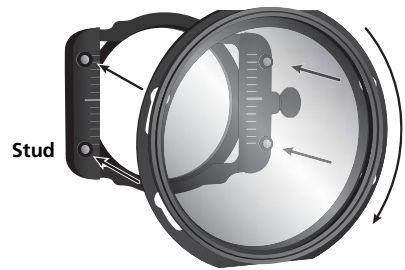

Stud

The Polariser clips onto the four studs on the front of the Holder with a click and twist action.

## Thread sizes

The holder attaches to the lens via a screw-in adaptor ring. The adaptor ring is available in the following thread sizes: 39, 40.5, 43, 46, 49, 52, 55, 58, 60, 62 and 67mm.



Adaptor ring

## The deluxe set

The components of the RF75 system can be purchased individually, or it is available as a set, which includes both filters and hardware.

In addition, a Deluxe Set features a holder, polarising filter and three neutral density graduated filters; all you need is to add the appropriate adaptor rings for your lenses.



Deluxe set

# The RF75 filter system

The RF75 filter system

## Joe Cornish tests the RF75 system

Rangefinder cameras are a favourite of professional and enthusiast photographers alike, being compact, highly robust and beautifully made. Their wideangle lenses can be the best in the business, which makes them a great choice for documentary and landscape photography, but using filters with them has, until now, been frustrated by holders that were either too large or too cumbersome.

The LEE RF75 system solves both these issues and is the most elegantly engineered filter holder now available. Engraved face plates on



the guide rails aid graduate filter positioning with non-reflex cameras (such as rangefinders). A unique polariser bayonet on to the holder much more conveniently than any comparable system. And LEE's complete filter range is available in the new 75mm width, including ND grads, the indispensable filters of the landscape photographer.

I recently tested the RF75 with the Hasselblad XPan, using the 30mm and 45mm lenses, and also the extraordinary digital Leica M8 rangefinder. It works beautifully, film or digital. Voigtlander, Zeiss Ikon, Mamiya 7 and Bronica 645 owners should be excited about it.



I can also reveal it works with some digital compacts, my own Ricoh GX100 for example.

As a footnote, I used the RF75 with my Ebony view camera in Scotland recently, as an alternative to my LEE 100 system, to reduce weight for mountaineering photography. Conclusion? It works brilliantly on any camera lens where the front filter thread does not exceed 67mm!

*Joe Cornish*  
Joe Cornish

The RF75 filter system



Cleveland Hills at sunset  
XPan, 30mm lens. 0.6 ND RF75 Hard Grad



Whitby Harbour early evening  
XPan, 30mm lens. 0.9 ND RF75 Hard Grad



Whitby Steps  
M8, Zeiss 21mm lens  
0.6 ND RF75 Hard Grad



Whitby  
M8, Zeiss 21mm lens (handheld)  
0.6 ND RF75 Hard Grad

the System

the System

# The RF75 filter system

The RF75 filter system



The filters for the RF75 system are manufactured to the same standards as those for the renowned 100mm system. Handmade in a way that meets the company's exacting quality control in colour and optical flatness, products in the LEE Filters range have become the benchmark by which other systems are judged, and are the indispensable tools of many photographic professionals worldwide.

RF75 Filters are not just cut down versions of the LEE 100mm System. In keeping with the smaller size, the graduation zones have been adjusted to suit the smaller system. These changes have been made through extensive testing and in conjunction with top landscape photographers to ensure the RF75 System is tailored to suit the needs of the cameras on which it will be used.

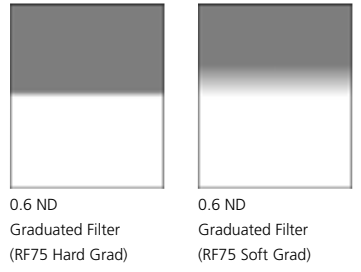

0.6 ND Graduated Filter (RF75 Hard Grad)

0.6 ND Graduated Filter (RF75 Soft Grad)

All filters are available individually and, because all LEE filters are handmade, if you want something out of the ordinary we can make that for you, too.

## ProGlass

Also available for the RF75 are the exciting ProGlass neutral density filters. These filters are glass neutral density standard filters that absorb visible, UV and IR radiation, making them particularly suitable for use with digital sensors, as well as giving a crisp, punchy result on film.

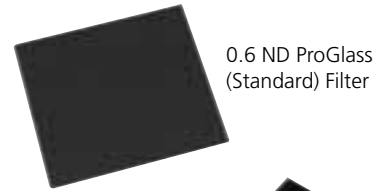

0.6 ND ProGlass (Standard) Filter

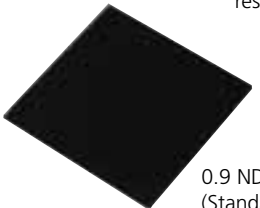

0.9 ND ProGlass (Standard) Filter

- RF75 Adaptor ring sizes: 39, 40.5, 43, 46, 49, 52, 55, 58, 60, 62 & 67mm.
- RF75 Filter Holder
- RF75 Deluxe Set – Filter Holder, Clip-on Polariser, 0.3ND, 0.6ND & 0.9ND Neutral Density RF75 Hard Graduated Filters
- RF75 Clip-on Polariser (circular type)
- RF75 Neutral Density Graduated Filter Set (RF75 Hard Grad) 0.3ND, 0.6ND & 0.9ND
- RF75 Neutral Density Graduated Filter Set (RF75 Soft Grad) 0.3ND, 0.6ND & 0.9ND
- RF75 Black and White Filter Set No.8 (Standard) No.11 (Standard) & No.23A (Standard)
- RF75 Basic Filter Set 0.6ND (RF75 Hard Grad), 0.6ND (Standard), 81B (RF75 Hard Grad)
- RF75 Advanced Filter Set 0.9 ND (Standard), 0.6ND to 81B Combination, 81B (Standard)
- RF75 Digital Basic Filter Set 0.6ND (RF75 Hard Grad), ProGlass 0.6ND (Standard), 81B (RF75 Hard Grad)
- RF75 Digital Advanced Filter Set ProGlass 0.9 ND (Standard), 0.6ND to 81B Combination, 81B (Standard)
- RF75 Individual Neutral Density Graduated Filters (RF75 Hard or RF75 Soft Graduation) 0.3ND, 0.45ND, 0.6ND, 0.75ND & 0.9ND
- RF75 Individual Neutral Density Standard Filters 0.3ND, 0.45ND, 0.6ND, 0.75ND & 0.9ND
- RF75 Individual ProGlass Neutral Density Standard Filters 0.6ND & 0.9ND

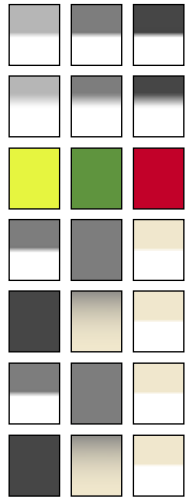

The entire range of LEE Resin Filters is available for the RF75 System. When ordering any filters for the RF75 System it is recommended that you prefix the filter name with 'RF75' to ensure you receive the correct size filters.

Below are some of the more widely used filters:

- Warm Up Filters Coral 3 (Grad), Straw 2 (Grad), 81A (Grad & Standard), 81C (Grad & Standard)
- Combinations 0.9ND with 81A, 0.6ND to 81C, 0.6ND to Straw 2

Individual filters can also be made to your specification, contact LEE Filters or your photographic dealer for details.

The RF75 filter system

The RF75 filter system

# lighting filters

## Pro-pack

The LEE Filters Pro-Pack kit contains 23 specially selected different sheets of filter material, and represents a versatile package for the studio.

15 colour effect-filters used for lighting backgrounds and creating special effects. Colours are yellow, straw, deep amber, orange, primary red, dark pink, magenta, peacock blue, dark blue, fern green, dark green, mauve, medium blue, flame red and deep lavender.

The four colour temperature correction grades (Full and Half Colour Temperature Blue, and Full and Half Colour Temperature Orange) are used to balance colour temperature when working in a combination of daylight and tungsten lighting conditions.

Two Neutral Density (0.3ND and 0.6ND) grades can be used to reduce the power of a flash head or studio lamp, to balance the intensities of lights or flash. Completing the package are two white diffusers, for use on their own or with other filters to eliminate shadows and soften the overall lighting effect.



## Reflector pack

Containing reflectors in mirror gold, mirror silver, soft gold and soft silver, the sheets are all manufactured from the same high quality, lightweight and flexible material that you would expect from LEE Filters. They can be used as they are or mounted on polystyrene or board for added rigidity. They are ideal for use in both the studio or out on location.

Pro-pack and reflector packs are available in 610mm x 530mm sheets.

## Polariser (lighting)

This is available in a 430mm by 300mm sheet and is intended for use with light sources. Care must be taken not to position the filter too close to a hot lamp.

## Colourmagic

The LEE Filters **colourMAGIC** series is a set of eight individual packs each containing a selection of 12 filters (250mm x 300mm), related to a particular aspect of lighting and studio work. **colourMAGIC** offers an opportunity to get to know the performance of the various filters on offer in a cost-effective way.



### Original pack

a specific selection of colours that can be used together to create a range of additional colours.



**Contents** - yellow, medium blue green, light blue, fern green, mauve, bright pink, heavy frost, no colour blue, chrome orange, dark lavender, flesh pink, brushed silk.

### Light tint pack

paler shades to give more subtle effects and to filter white light from the lamp.



**Contents** - lavender tint, pale yellow, pale amber gold, light pink, mist blue, pale blue, straw, pale rose, bastard amber, lilac tint, white flame green, hollywood frost.

### Studio pack

a range of technical filters for basic light source control.



**Contents** - 2x full C.T.B, 2x three quarters C.T.B, 2x full C.T.O, 2x three quarters C.T.O, 0.15 neutral density, 0.3 neutral density, 0.6 neutral density, 0.9 neutral density.

### Tint pack

lighting filters which complement the original colour magic pack to create alternative shades.



**Contents** - rose pink, rose purple, lime green, spring yellow, english rose, marine blue, pink, flame red, dark steel blue, brushed silk, half white diffusion, violet.

### Studio plus pack

a range of technical filters for fine control of light sources.



**Contents** - 2x half C.T.B, 2x quarter C.T.B, 2x eighth C.T.B, 2x half C.T.O, 2x quarter C.T.O, 2x eighth C.T.O.

### Complementary pack

a starter pack for exploring the basics of colour addition and subtraction.



**Contents** - flame red, dark green, dark blue, loving amber, dark steel blue, pale green, yellow, peacock blue, bright pink, pale yellow, steel blue, light pink.

### Saturates pack

a selection of strong and vibrant colours for more intense colour combinations.



**Contents** - medium red, yellow, orange, medium blue green, deep blue, mauve, heavy frost, deep golden amber, primary green, congo blue, light red, special rose pink.

### Arc correction pack

a selection of technical filters for colour correction.



**Contents** - 2x half C.T.O, 2x quarter C.T.O, Lee fluorescent green, Lee fluorescent 5700K, Lee fluorescent 4300K, Lee fluorescent 3600K, 2x full plus green, 2x half plus green.

The C.T.B. and the C.T.O. and their derivatives are designed to change the colour temperature of the light source on which they are placed. See LEE Filters lighting brochure for further information.

80A	42, 44	ColourMAGIC series - Light tint pack	61	Gel snap	50	Neutral density 0.6 (resin)	6, 22, 39	Real blue 1	22, 39	Straw 3	29, 37
80B	42, 44	ColourMAGIC series - Original pack	61	Glass enhancer	36	Neutral density 0.75 (resin)	22, 39	Real blue 2	39	Straw stripe	29, 37
80C	42, 44	ColourMAGIC series - Saturates pack	61	Glass filters	20	Neutral density 0.9 (resin)	6, 22, 39	Real blue 3	29, 39	Stripe set	32
80D	42, 44	ColourMAGIC series - Studio pack	61	Glass soft focus filter	34	Neutral density filters (polyester)	45	Red CC filter	47	Sunrise set	29
81	42, 44	ColourMAGIC series - Studio plus pack	61	Green 1	32, 38	Neutral density graduated	22, 27	Red pop	37	Sunset 1, 3	37
81A	42, 44	ColourMAGIC series - Tint pack	61	Green CC filter	47	Neutral density set (polyester)	43	Reflector pack	60	Sunset 2	28, 37
81B	42, 44	Colour temperature adjustment filters	44	Green pop	38	Neutral density set (resin)	27	Resin filters	20, 26	Sunset orange	31, 37
81C	42, 44	Colour temperature set	42	Hard graduated filters	21	Neutral density single filters (polyester)	45	RF75 kit	7, 53	Sunset red	31, 37
81D	42, 44	Combination filters (comb)	45	HPS-B	46	Neutral density single filters (resin)	39	Selective star set	33	Sunset set	31
81EF	42, 44	Coral 1, 3, 5, 7, 8, 9, 10, 11, 12, 13, 14	38	HPS-D	46	Neutral density standard	23	Sepia 1, 3	38	Sunset yellow	31, 37
81EFN3, 81EFN6, 81EFN9	45	Coral 2	30, 38	Holders	10, 11, 12, 13	Noton, David: Chasing the light	8	Sepia 2	29, 38	System accessories	50
82	44	Coral 4	30, 38	Infrared (IR)	47	Pale coral stripe	31, 37	Single effect resin filters	37	Technical filters	41
82A	42, 44	Coral 6	30, 38	Inspiring professionals	8	Pale tint set	32	Sky blue 1, 2	30, 39	Technical filter sets	42
82B	44	Coral set	30	Landscape set	29	Pink 1	32, 39	Sky blue 3	28, 30, 39	Tobacco 1, 3	38
82C	42, 44	Coral stripe	28, 38	Leather filter pouch	52	Pink stripe	32, 39	Sky blue 4, 5	39	Tobacco 2	28, 38
85	44	Cyan	31, 39	Lens adaptors	14	Polariser (lighting)	60	Sky blue set	30	Tricolour filters (TR)	47
85BN3, 85BN6, 85BN9	45	Cyan 1 cyan CC filter	47	Lens hoods	16	Polarising filters	8, 24	Sky set	28	Tungsten fluorescent set	42
85N3, 85N6, 85N9	45	Cyan stripe	32	Lighting filters	60	Polyester filters	20	Slotted filter hood	18	Twilight	31, 39
Accessories	50, 51	Cyan 1 cyan CC filter	47	Low contrast 1/4, 1/2, 3/4, 1, 1 1/2	40	Pop blue	32, 38	Slotted wideangle lens hood	17	Twilight set	31
Adaptor rings	14, 15	Cyan stripe	32	Magenta	31, 39	Pop green	32, 38	Soft focus filters	34	Ultraviolet absorbing filters (CC/CT)	46
Arc correction filters (CC/CT)	46	Daylight fluorescent set	42	Magenta CC filter	47	Pop red	32, 37	Soft graduated filters	21	Universal lens hood	5, 17
Autumn tint set	28	Digital starter kit	4	Magenta set	43	Pop set	32	Soft set	35	Upgrade kit	12
Black & white set	43	Double slotted filter hood	18	Mahogany 1	29, 39	Pouches	52	Soft 1, 2, 3, 4, 5	35	Warm-up set	42
Black & white filters (CC/CT)	48	Effects filters	27	Mahogany 2	39	Professional kit	13	Specialist filter holders	13	Wideangle lens hood	17
Blue CC filter	47	Filter versatility	13	Mahogany 3	31, 39	ProGlass filters	23	Standard hood	18	Yellow	31, 37
Blue pop	32, 38	Fine colour temperature set	42	Mist graduated	40	Pro-pack	60	Starter kit	4	Yellow CC filter	47
Blue stripe	38	FL 3600-B	42, 46	Mist clear spot	33, 40	Push-on filter holder	13	Star eight point	40	Yellow stripe	32, 37
Chocolate 1	38	FL 3600-D	42, 46	Mist set	33			Star four point	40		
Chocolate 2	29, 38	FL 4300-B	42, 46	Mist stripe	33, 40			Star graduated	33, 40		
Colour compensating filters (CC/CT)	47	FL 4300-D	42, 46	Multi-filter pouch	52			Star segment	33, 40		
Colour control filters	44	FL 5700-B	42, 46	MV-B	46			Star six point	40		
Colour grad set	31	FL 5700-D	42, 46	MV-D	46			Star spot	33, 40		
ColourMAGIC series	61	Fluorescent correction filters (CC/CT)	46	Net black 1	33, 40			Straw 1	37		
ColourMAGIC series - Arc correction pack	61	Fog 1, 2, 3, 4, 5	40	Net black 2	33, 40			Straw 2	29, 37		
ColourMAGIC series - Complementary pack	61	Foundation kit	5, 12	Net set	33						
				Net white	33, 40						
				Neutral density 0.3 (resin)	6, 22, 39						
				Neutral density 0.45 (resin)	22, 39						

## Contact details

**LEE Filters**, Central Way, Walworth Industrial Estate, Andover, Hampshire, SP10 5AN UK

T: + 44 (0) 1264 366245 F: + 44 (0) 1264 355058

e-mail: [sales@leefilters.com](mailto:sales@leefilters.com) [www.leefilters.com](http://www.leefilters.com)

**LEE Filters USA**, 2237 North Hollywood Way, Burbank, CA 91505 USA

T: (800) 576 5055 F: (818) 238 1228 [www.leefilters.com](http://www.leefilters.com)

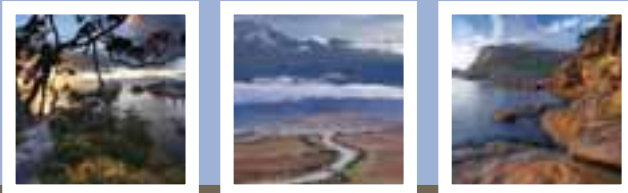

INSPIRING PROFESSIONALS

[www.leefilters.com](http://www.leefilters.com)